



Dell Storage MD1400 and MD1420 Enclosures Deployment Guide



Notlar, Dikkat Edilecek Noktalar ve Uyarılar

-  **NOT:** NOT, bilgisayarınızı daha iyi kullanmanızı sađlayan önemli bilgileri anlatır.
-  **DİKKAT: DİKKAT,** donanımda olabilecek hasarları ya da veri kaybını belirtir ve bu sorunun nasıl önleneceđini anlatır.
-  **UYARI: UYARI,** meydana gelebilecek olası maddi hasar, kişisel yaralanma veya ölüm tehlikesi anlamına gelir.

Telif hakkı © 2014 Dell Inc. Tüm hakları saklıdır. Bu ürün, A.B.D. ve uluslararası telif hakkı ve fikri mülkiyet yasaları tarafından korunmaktadır. Dell™ ve Dell logosu, Amerika Birleşik Devletleri ve/veya diğer ülkelerde, Dell Inc.'e ait ticari markalardır. Burada adı geçen diğer tüm markalar ve isimler, ilgili firmaların ticari markalarıdır.

2014 - 09

Rev. A00

Contents

1 Introduction.....	4
2 Connecting the enclosure.....	5
Before you begin.....	5
Procedure to connect the enclosure.....	5
Cabling your enclosure	7
Single port configuration.....	7
Redundant configuration.....	8
Multi-chain configuration.....	9
3 Managing your storage enclosure.....	11
4 Downloading firmware.....	12
5 Getting help.....	13
Locating your system service tag.....	13
Documentation feedback.....	13
Related documentation.....	13

Introduction

An enclosure containing physical disk drives accessed through EMMs (Enclosure Management Modules) is called a storage enclosure. A storage enclosure includes various hardware components such as physical disk drives, EMMs, fans, and power supply units (PSUs). One or more host systems attached to the storage enclosure can access the data on the storage enclosure. You can also establish multiple physical network paths between the hosts and the storage enclosure so that loss of any single path (for example, if a host system port stops functioning) does not result in any issues accessing the data on the storage enclosure.

The Storage Enclosure Management software running on a host system manages the storage enclosure. On the host system, the management software and the storage enclosure communicate management requests and event information using in-band SAS connections.





Connecting the enclosure

The storage enclosure is connected to a host server by using one or both of the two EMMs. The EMMs are named as EMM 0 and EMM 1.

You can connect the enclosure in three different configurations:

- Single Port Configuration
- Redundant Configuration
- Multi-chain Configuration

Before you begin

-  **WARNING:** Whenever you lift the system, get others to assist you. To avoid injury, do not lift the system by yourself.
-  **WARNING:** Opening or removing the system cover when the system is turned on may expose to a risk of electric shock.
-  **CAUTION:** Do not operate the system without the cover for a duration exceeding five minutes.
-  **CAUTION:** A certified service technician can only perform the repairs. Troubleshoot and perform simple repairs as authorized in your product documentation, or as directed by the online or telephone service and support team. Damage because of the service that is not Dell authorized is not covered in the warranty. Read and follow the safety instructions shipped with the product.

Before connecting your storage enclosure, make sure that the following are available:

- Power cables
- SAS cables
- Rail kit
- Dell systems management applications and documentation media
- The latest version of Dell OpenManage Server Administrator is installed. For more information about installation instructions and supported operating systems, see the Server Administrator documentation available at dell.com/openmanagemanuals.

Procedure to connect the enclosure

To connect the enclosure to a host system:

1. Turn off the host system and all attached storage devices.
2. Connect the SAS cable to EMM SAS connector on the storage enclosure and to the RAID controller on the host system. Push the cable into the connector until it clicks into place. See Figure 1.

 **NOTE:**

- Connectors on both ends of the SAS cable are universally keyed. You can connect either end of the cable to the EMM or the RAID controller.
- To remove the SAS cable, pull the pull-tab to release the cable from the connector on the EMM and the host system. See Figure 1.

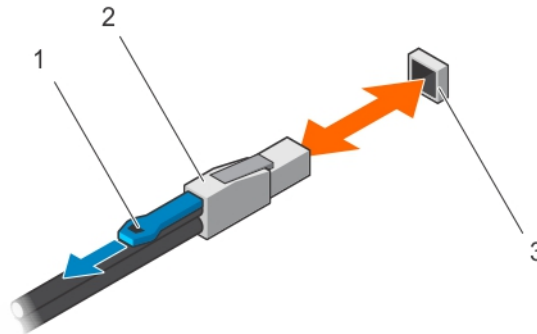



Figure 1. Connecting a SAS cable

1. Pull-tab
2. SAS cable
3. SAS port (In/Out)

 **NOTE:**

- To make sure that the controller is correctly installed, see your RAID controller documentation at dell.com/storagecontrollermanuals.
- For more information about single port configuration, redundant configuration, multi-chain configuration, see [Cabling Your Enclosure](#).

 **CAUTION:** To safeguard storage enclosure against power problems, connect the AC power cable to a protected PSU, such as a UPS, line conditioner, or surge protector. If possible, connect the two PSUs to different circuits.

3. Connect PSUs to the power source.



NOTE: Before connecting the PSUs, make sure that the power switch on both PSUs is turned off.

4. Turn on the PSUs or cooling fan modules.
5. Turn on the host system.
6. Check the LED indicators on the front- and back panel of the storage enclosure. For more information about LED indicators, see the *Dell Storage MD1400 Enclosures Hardware Owner's Manual* at dell.com/powervaultmanuals.

Cabling your enclosure

You can cable the storage enclosure to host systems and to additional storage enclosures in three different configurations:

- Single port configuration
- Redundant configuration
- Mutli-chain configuration



NOTE: Clustering is not supported on MD1400 and M1420 enclosures.

Related Links

[Single port configuration](#)

[Redundant configuration](#)

[Multi-chain configuration](#)

Single port configuration

Single Port configuration supports up to four enclosures. The enclosures are daisy-chained with one of the enclosures connected to a single port on the controller card. See Figure 2.

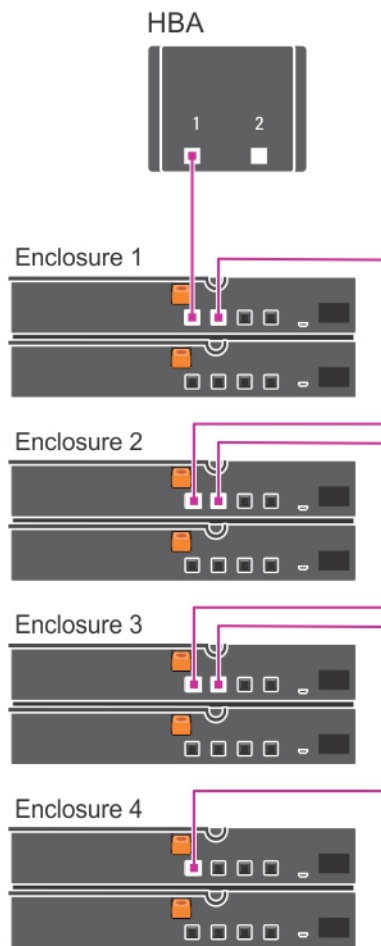

Figure 2. Single port configuration

Redundant configuration

In Redundant configuration, the enclosures are daisy-chained with one of the enclosures connected to both the ports on the controller card. See Figure 3.

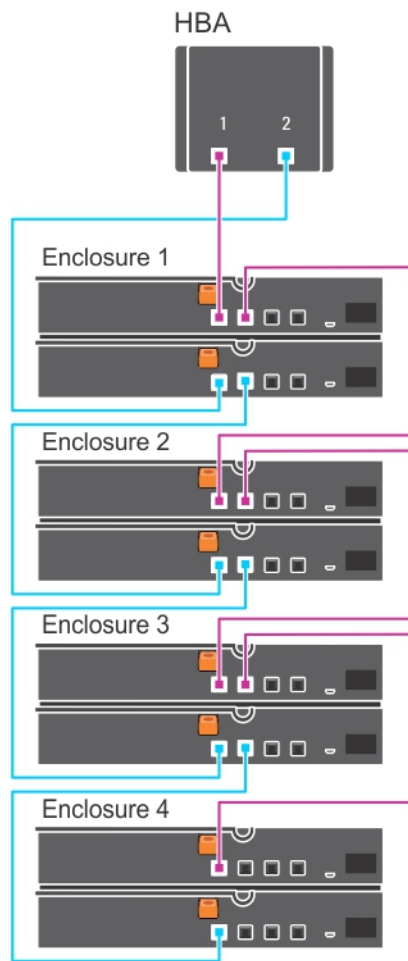

Figure 3. Redundant configuration

Multi-chain configuration

Multi-chain configuration supports up to eight enclosures. The first four enclosures are daisy-chained with one of the enclosures connected to a single port on the controller card. The second four enclosures are daisy-chained with one of the enclosures connected to the second port on the controller card. See Figure 4.

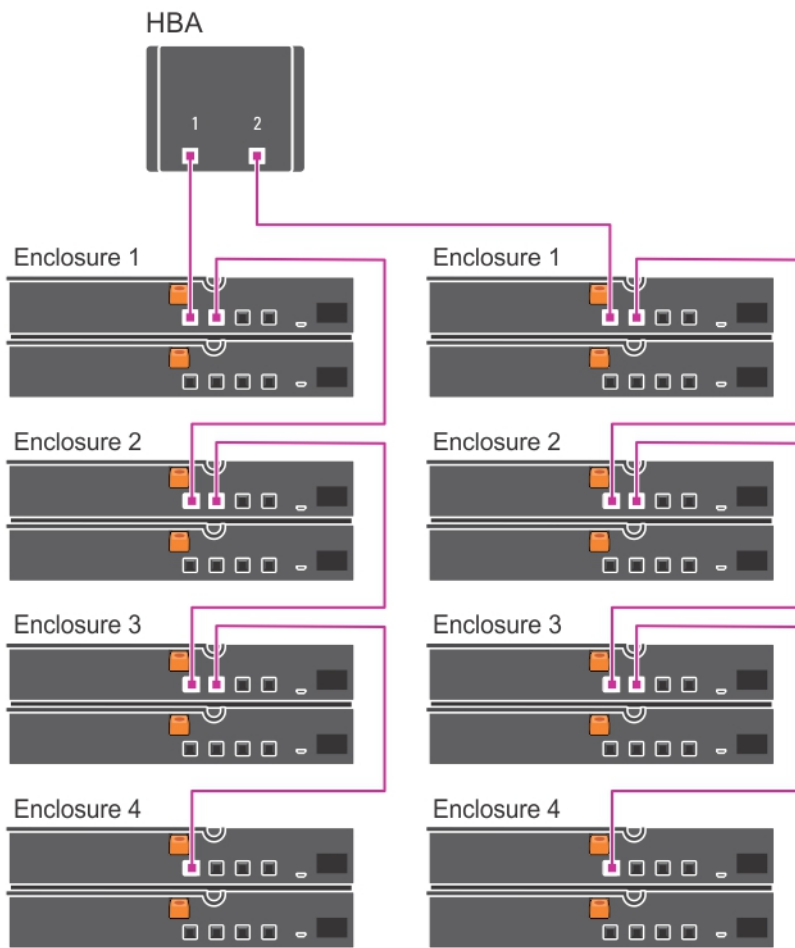



Figure 4. Multi-chain configuration

Managing your storage enclosure

Physical disk drive storage within the enclosure can be configured using either the BIOS configuration utility or Server Administrator. For optimal management and serviceability of your enclosure, it is recommended that you use Server Administrator available at dell.com/openmanagemanuals.

 **NOTE:** Online configuration, enclosure status, and active event notification is supported only with Server Administrator version 6.2 or later.

Server Administrator provides a comprehensive server or storage management solution with an integrated graphical view and command line interface (CLI). It enables online configuration and management for both internal storage and externally attached storage.

Server Administrator obtains information about physical storage devices, disk enclosures, virtual disks or RAID arrays, and logical devices. The information is displayed in both physical and logical views.

By using Server Administrator you can:

- create and manage RAID storage configurations
- display storage information
- customize event reporting
- view logged events

For more information, see the Server Administrator documentation at dell.com/support/manuals.

Downloading firmware

You can download firmware updates for storage enclosure using the Dell Update Package available at dell.com/support.

Getting help





Locating your system service tag

Your system is identified by a unique Express Service Code and Service Tag number. The Express Service Code and Service Tag are found on the back of the system by pulling out the luggage tag. Alternatively, the information may be on a sticker on the chassis. This information is used by Dell to route support calls to the appropriate personnel.

Documentation feedback



If you have feedback about this document, write to documentation_feedback@dell.com. Alternatively, you can click the **Feedback** link in any of the Dell documentation pages. Fill out the form and click **Submit** to send your feedback.

Related documentation

-  **WARNING:** Sisteminizle birlikte gelen güvenlik ve düzenleme bilgilerine bakın. Garanti bilgileri bu belgeye dahil edilmiş veya ayrı bir belge olarak eklenmiş olabilir.
-  **NOTE:** For all PowerEdge documentation, go to dell.com/support/manuals and enter the system Service Tag to get your system documentation.
-  **NOTE:** For all Dell OpenManage documents, go to dell.com/openmanagemanuals.
-  **NOTE:** For all operating system documents, go to dell.com/operatingsystemmanuals.
-  **NOTE:** For all storage controllers and PCIe SSD documents, go to dell.com/storagecontrollermanuals.

Your product documentation includes:

- The *Getting Started Guide* provides an overview of system features, setting up your system, and technical specifications. This document is also shipped with your system. This document is available online at dell.com/powervaultmanuals.
- The *Owner's Manual*, which provides information about system features and describes how to troubleshoot the system and install or replace system components. This document is available online at dell.com/powervaultmanuals.
- The *Setting Up your Dell Storage enclosure placemat* provides information about setting up the enclosures. This document is also shipped with your system. This document is available online at dell.com/powervaultmanuals.
- Any media that ships with your system provides documentation and tools for configuring and managing your system, including those pertaining to the operating system, system management software, system updates, and system components that you purchased with your system.

-  **NOTE:** Her zaman dell.com/support/manuals adresindeki gncelleřtirmeleri kontrol edin ve genellikle diđer belgelerdeki bilgileri geersiz kıldıđından, ncelikle gncelleřtirmeleri okuyun.
-  **NOTE:** When upgrading your system, it is recommended that you download and install the latest BIOS, driver, and systems management firmware on your system from dell.com/support.